

FIG. 1

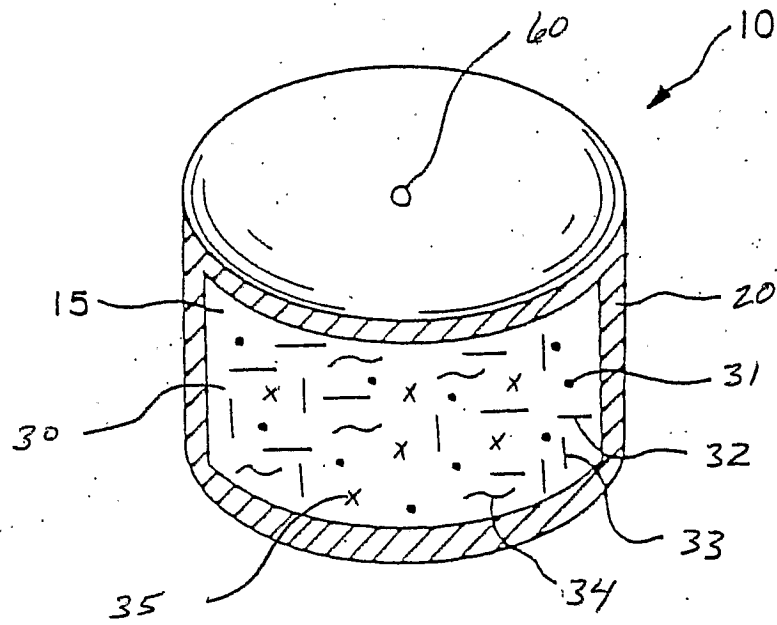

FIG. 2

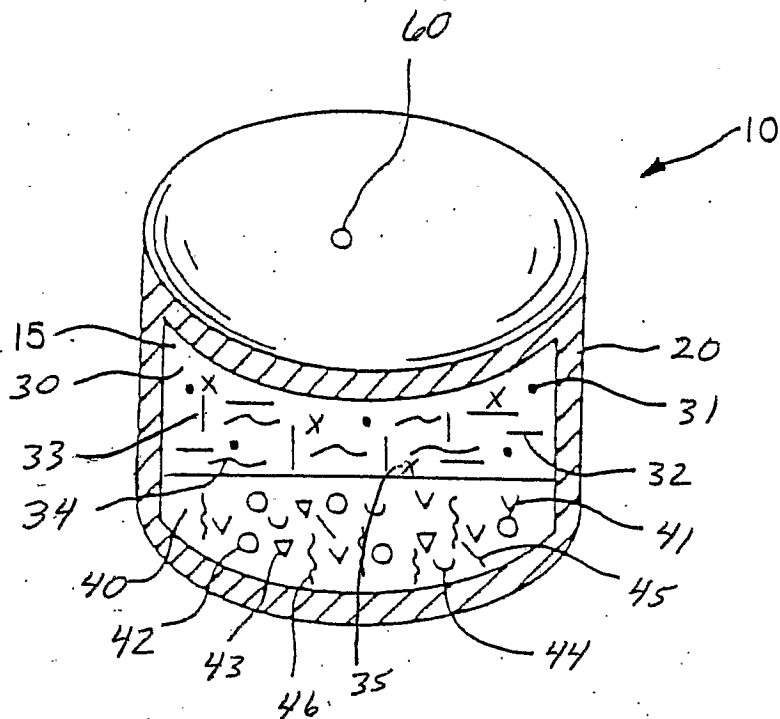

FIG. 3

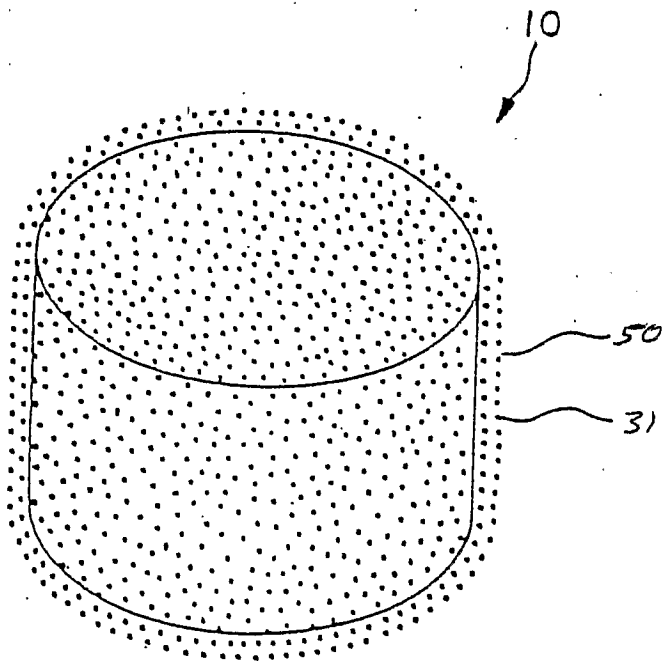

FIG. 4

Oxycodone HCl Single Dose 20 mg

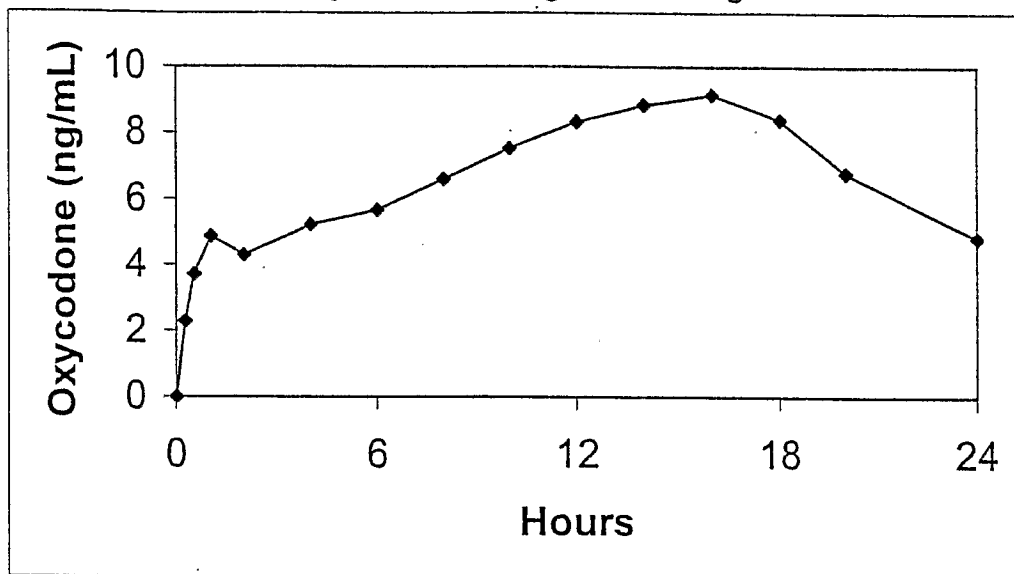

FIG. 5

Oxycodone HCl Multiple Dose 20 mg

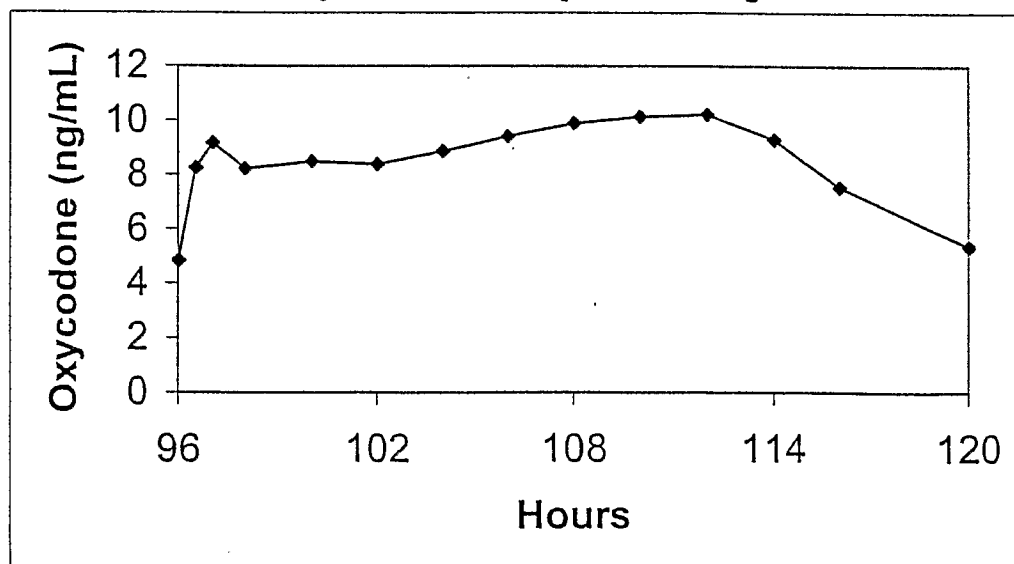

FIG. 6

Release rate of Oxycodone HCl 20 mg

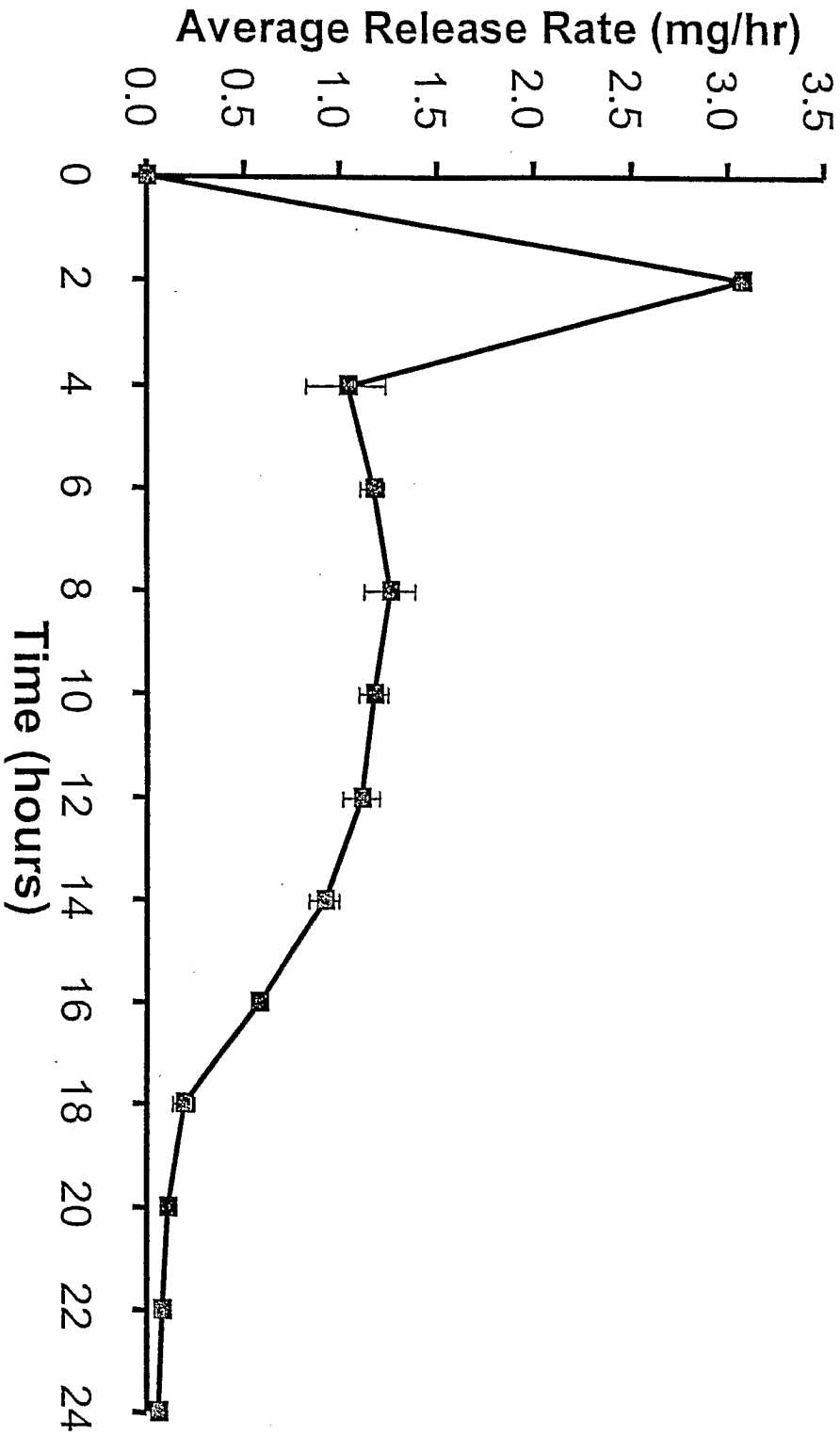
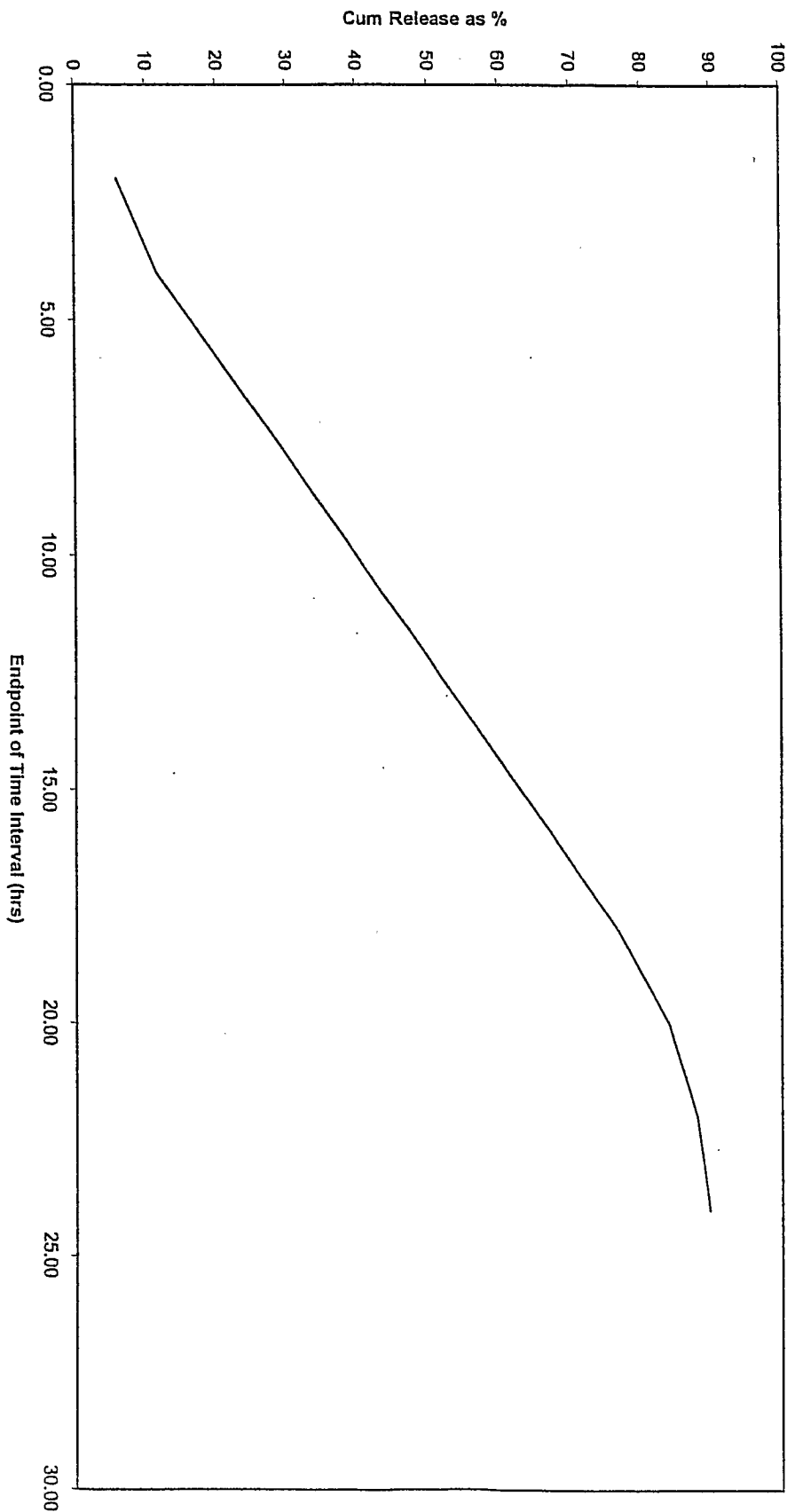
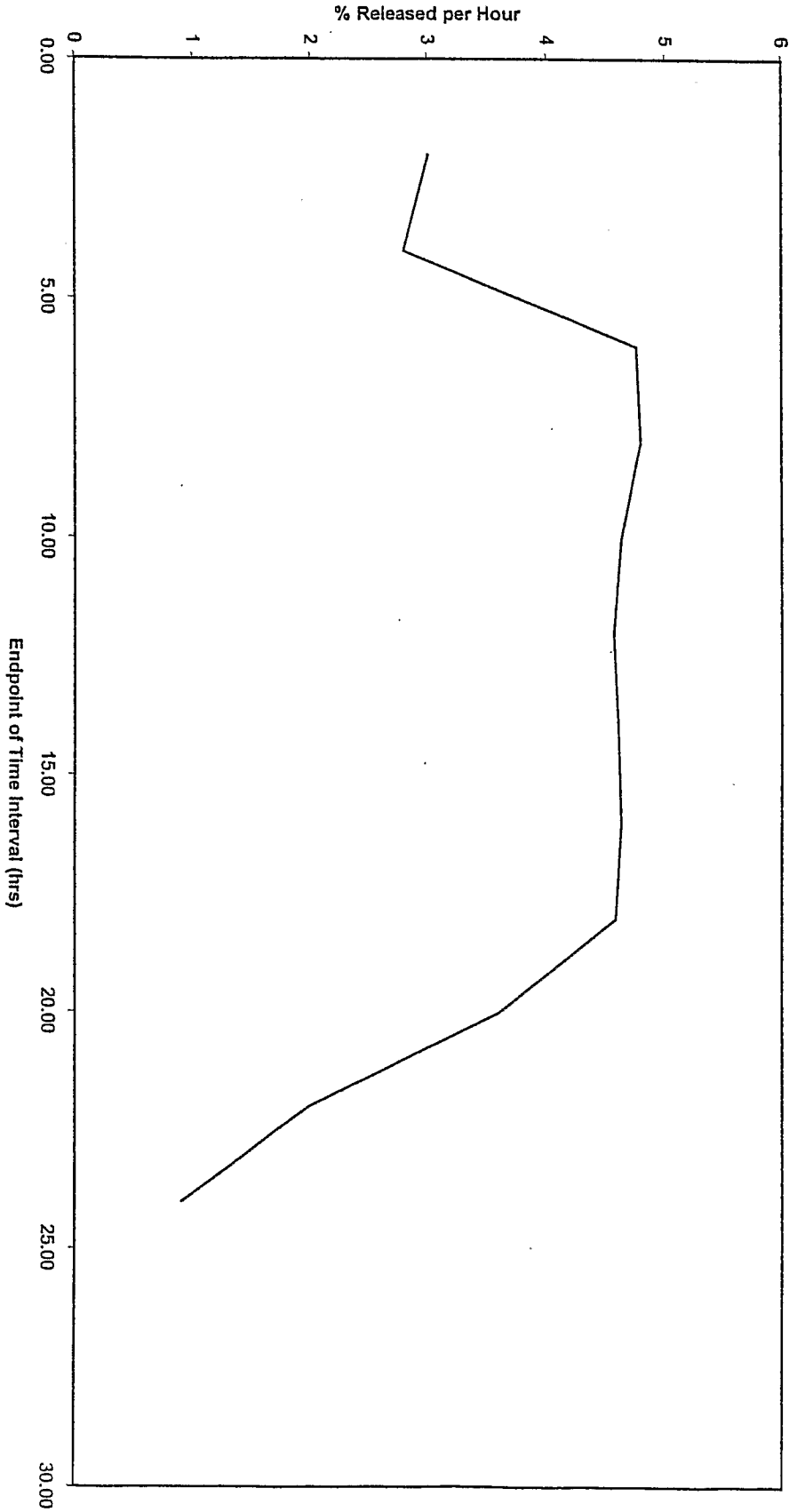

FIG. 7

Cumulative release of Oxycodone HCl 20 mg
FIG. 8



Release rate of Oxycodone HCl 20 mg
FIG. 9



Cumulative release of Oxycodone HCl, 80 mg
FIG. 10

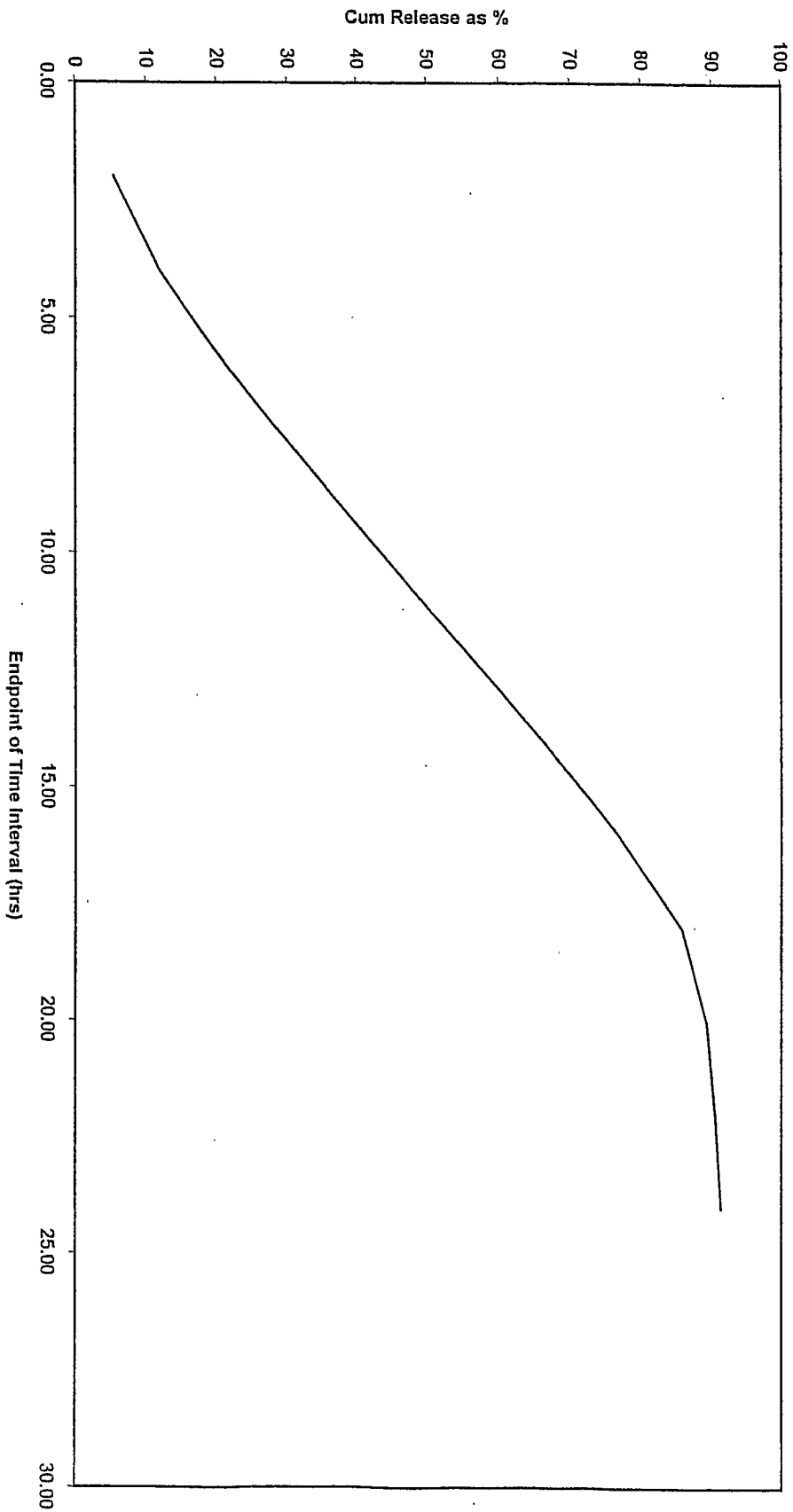

Release rate of Oxycodone HCl, 80 mg
FIG. 11

